

SIENA

Miniature NIR spectrometer for portable and industrial integration

Key Features

- Wavelengths between 800 and 2100 nm
- Low-power uncooled InGaAs sensor
- Excellent stray light performance
- Miniature size



The Siena takes near-infrared spectroscopy to a new level. It combines the performance and flexibility of an array-based spectrometer with the size, price and reliability required for mobile applications and industrial sensors. For the first time it offers wavelength ranges up to 2100 nm with an uncooled InGaAs array sensor.

NIR spectrometers are usually either high-performance or low-cost. The Siena delivers the technical performance for precise measurements at a price suitable for integration in portable and industrial sensors. Large absorbance values can be accurately measured due to its superior sensitivity, optimized stray light suppression and high dynamic range.

The Siena includes the flexibility to adapt it to a specific application: It is available in three standard wavelength ranges that can be customized to increase resolution. The default entrance slit of 20 µm is user-replaceable and can be easily exchanged to obtain better sensitivity. Its powerful microcontroller performs on-board auto exposure, averaging, buffering and spectrum processing. In addition, it enables the implementation of application-specific spectrum evaluation.

Delivering exceptional performance at an unprecedented price, the Siena opens up countless new possibilities for NIR-based sensors.

Optics

Optical design	Symmetrical high-throughput Czerny-Turner
Focal length	30 mm
Numerical aperture	0.19 (equivalent area)
Stray light	0.08 %
Detector lens	Included
Order sorting filter	Included (if required)
Optical interface	SMA connector (other interfaces on request)

Wavelength ranges and resolutions

The Siena is available in the following standard configurations. Contact us for customized wavelength range.

Configuration	Wavelength range	Resolution (FWHM)	
		typ.	max.
SIENA 1.7	850 – 1700 nm	8 nm	10 nm
SIENA 1.9	800 – 1900 nm	11 nm	13 nm
SIENA 2.1	900 – 2100 nm	12 nm	15 nm

Resolutions are given for the default 20 µm entrance slit. A larger entrance slit typically increases both the resolution and the sensitivity proportional to its width. The wavelength accuracy is typically 1/3 of the resolution.

Image Sensor

The Siena uses a new InGaAs line sensor with a built-in dark current compensation. Traditional InGaAs sensors beyond 1700 nm need to be cooled to prevent quick saturation by dark current. The Siena can be operated up to 2100 nm at room temperature without cooling. This eliminates the need for a fan and reduces the overall size and power consumption.

Sensor type	InGaAs
Number of pixels	256
Exposure time range	4 µs – 10 min
Signal-to-Noise Ratio *	5000
Dynamic Range **	12000 : 1
Readout noise ***	4 counts RMS
Trigger jitter	≤ 1 µs

* Maximum Signal-to-Noise Ratio without averaging

** Without averaging, for a single pixel

*** Typical value for a single exposure, scaled to 16 bit

Electronics

Power supply	5 V via USB or Aux connector
Supply voltage range	4.4 – 5.5 V
Power consumption	≤ 60 mA
A/D converter	16 bit, 2 MHz
Non-linearity	< 1 %
Spectrum buffer size	426 spectra
Auto exposure	On-board during measurement (exposure time and averaging)
Fastest repetition time	0.34 ms
Transfer time to host PC via USB (32 bit)	6 ms
Transfer time to host PC via USB (16 bit)	4 ms
On-board processing	Averaging, buffering and spectrum processing (offset, non-linearity, dark and reference spectrum)
Digital interfaces	USB 2.0 full speed, UART On request: SPI, I ² C
I/O connections	Trigger in, Trigger out, Analog in, Analog out. On request: programmable I/O pins (GPIO), Pulse generator for flash lamps
Connectors	USB Type-C 16-pin Aux connector (IDC)

Absolute maximum ratings

	Minimum	Maximum (power on)	Maximum (power off)
Supply voltage	-0.3 V	5.5 V	
Analog input pins	-0.3 V	4.0 V	3.6 V
Digital input pins	-0.3 V	6.0 V	3.6 V
Output pins	do not apply any voltage		
Temperature	-40 °C	70 °C	70 °C

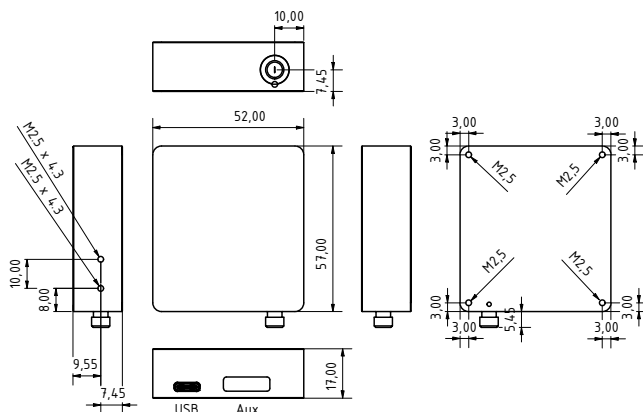

All information is subject to change. The most recent version of this datasheet can be found on our website.

Version 1.0.4 - 2026-03-27

Mechanics and environmental conditions

Dimensions	52.0 × 57.0 × 17.0 mm *
Weight	80 g
Storage temperature	-40 to 70 °C
Operating temperature	-20 to 60 °C
Humidity	0 to 90 % non-condensing

* Without optical interface, see technical drawing below.

Included accessories

- USB cable
- USB memory stick with software and documentation
- Quick start guide
- Calibration and test report

Optional accessories

- Larger entrance slits (user-replaceable)
Available slit sizes: 10, 20, 50, 75, 100, 150, 200, 300 μm
- Fiber-optical patch cables
- SMA collimator
- Direct-attach collimator

Custom options

- Custom wavelength ranges and blaze wavelengths
- Additional optical filters
- Application-specific processing and evaluation

Included software

- Application software (Windows 7 and later)
- Software Development Kit (SDK) with Demo code, drivers and protocol documentation

Compliance

The Siena complies with the relevant EU regulations and standards concerning electromagnetic compatibility (2014/30/EU), RoHS (Restriction of Hazardous Substances) SVHC (Substances Of Very High Concern) as well as the U.S. Congo Conflict Minerals Act. Details can be found in the user manual.

Ordering Information

Part number: SIENA-AAA-BBB-CC

AAA: Start wavelength in nm

BBB: End wavelength in nm

CC: Entrance slit width in μm

Contact

Avenir Photonics GmbH & Co. KG

Franz-Mayer-Str. 1, 93053 Regensburg
Germany

Phone: +49 941 462972-80

sales@avenirphotonics.com

support@avenirphotonics.com

www.avenirphotonics.com

Avenir
PHOTONICS